

FRONT: Sticker 1160 x 757 mm

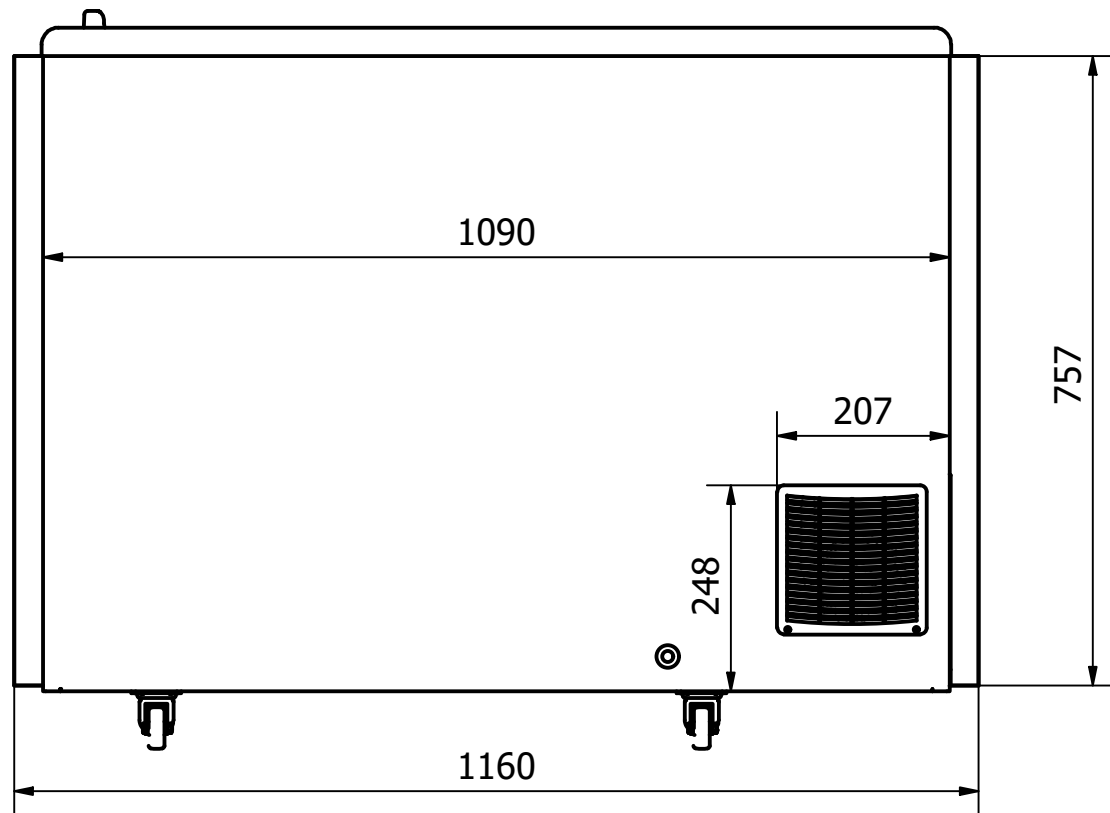

RIGHT SIDE: Sticker 675 x 757 mm

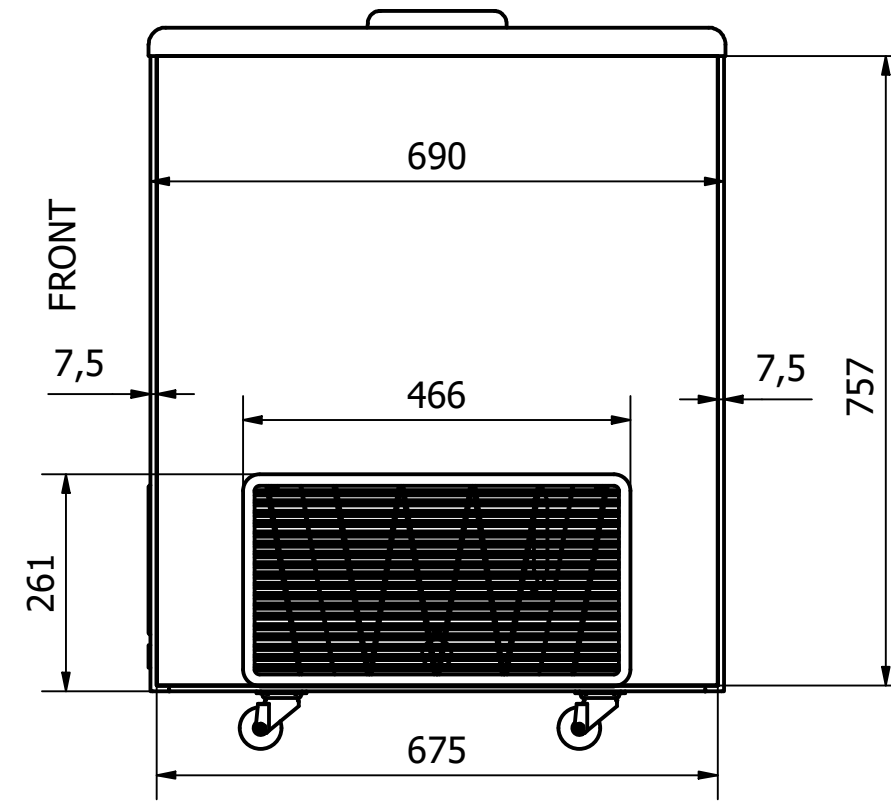

BACK: Sticker 1160 x 757 mm

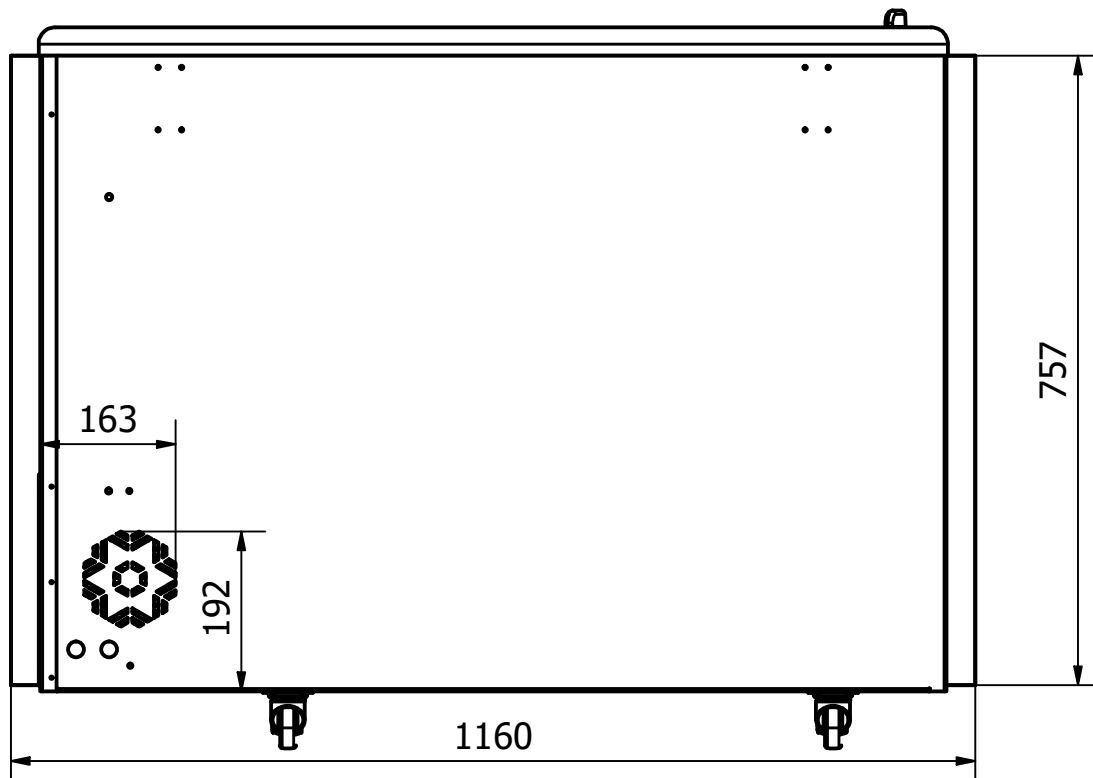

LEFT SIDE: Sticker 675 x 757 mm

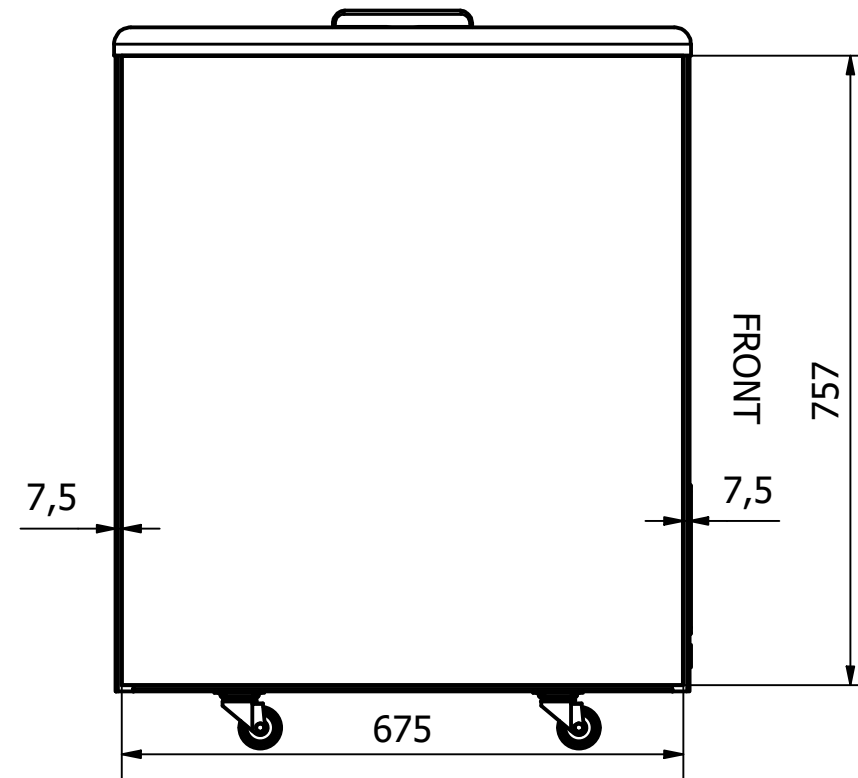

Comments:

The FRONT and the BACK stickers will be taken around the corners by approx. 35 mm in each side
The SIDE stickers will be mounted approx. 7,5 mm from the FRONT and 7,5 mm from the BACK